

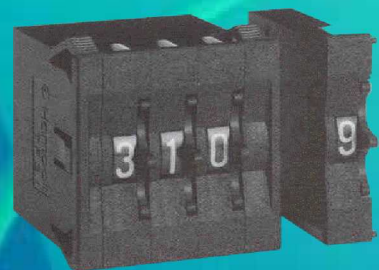

**Pushwheel
Switch**

**Thumbwheel
Switch**



Rotary DIP Switch

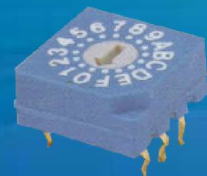
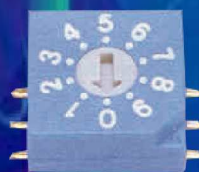
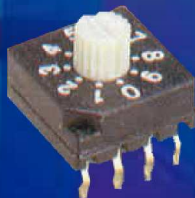
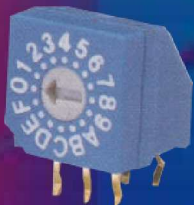

Pushwheel



Produto	Tamanho	Tipo	Circuito	Série	Preço
GPF521221	Pequeno	BCD	Longo	Botões +/-	3.50
GPF521211	Pequeno	BCD	Curto	Botões +/-	3.30
GPF522221	Pequeno	DEC	Longo	Botões +/-	3.50
GPF522211	Pequeno	DEC	Curto	Botões +/-	3.30
GPF461221	Médio	BCD	Longo	Botões +/-	3.40
GPF461211	Médio	BCD	Curto	Botões +/-	3.20
GPF462221	Médio	DEC	Longo	Botões +/-	3.40
GPF462211	Médio	DEC	Curto	Botões +/-	3.20
GPF311221	Grande	BCD	Longo	Botões +/-	3.80
GPF311211	Grande	BCD	Curto	Botões +/-	3.60
GPF312221	Grande	DEC	Longo	Botões +/-	3.80
GPF312211	Grande	DEC	Curto	Botões +/-	3.60

Thumbwheel

Produto	Tamanho	Tipo	Circuito	Série	Preço
GTF311221	Grande	BCD	Longo	Roda	3.40
GTF311211	Grande	BCD	Curto	Roda	3.30
GTF312221	Grande	DEC	Longo	Roda	3.40
GTF312211	Grande	DEC	Curto	Roda	3.30

Acessórios

Produto	Descrição	Preço
GPF52E10	Par de laterais p/ PF52	0.40
GPF46E10	Par de laterais p/ PF46	0.40
GPF31E10	Par de laterais p/ PF31	0.40
GTF31E10	Par de laterais p/ TF31	0.40
GPF46N02	Pino de parada p/ PF46	0.05

Rotary Switches

Produto	Preço	Produto	Preço
RM30012	2.60	RS30012	2.40
RR30012	2.80	RS40312	2.40
RR30712	2.80	Produto c/ cód.final 4(Hexa):acrescentar	0.10

Preços em US\$ comercial venda, do dia do faturamento ICMS incluso, IPI incluso.

Descontos especiais conforme quantidade solicitada

Pushwheel Switch: GPF52



BCD

(GPF5212XX)

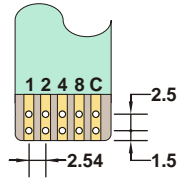

DECIMAL CURTO

(GPF522211)

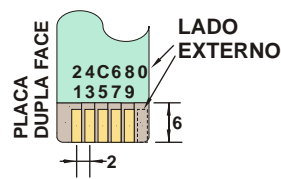

DECIMAL LONGO

(GPF522221)

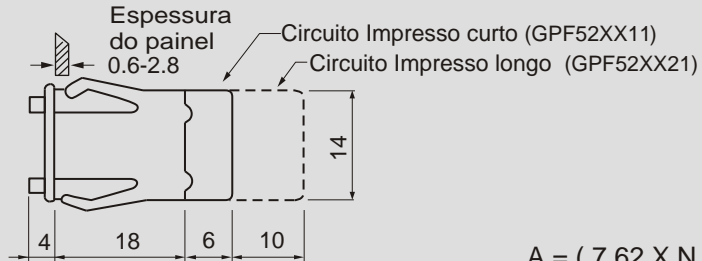
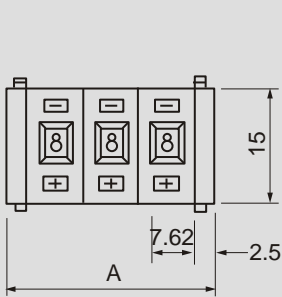
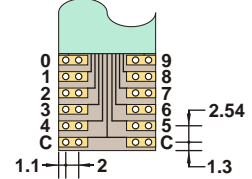

$$A = (7.62 \times N) + 5$$

$$B = (7.62 \times N) + 3$$

$$C = (7.62 \times N) + 3.3$$

N = Número de módulos

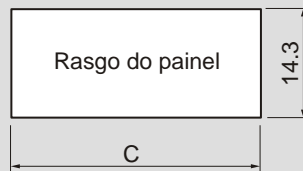
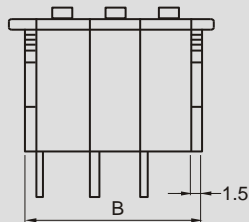

D Comércio e Assessoria

Pushwheel Switch: GPF46



BCD

(GPF4612XX)

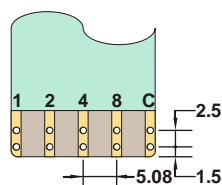

DECIMAL

(GPF462221)

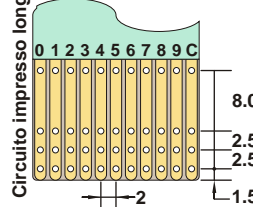

(GPF462211)

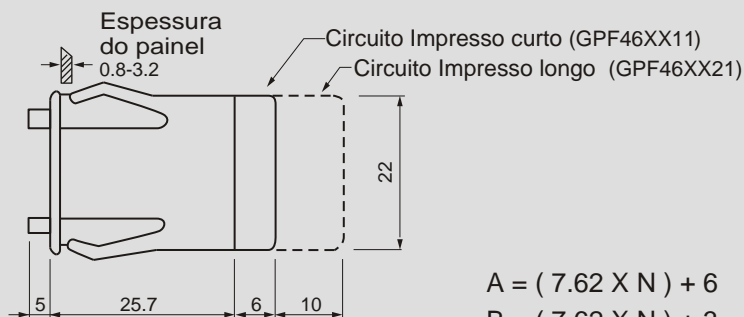
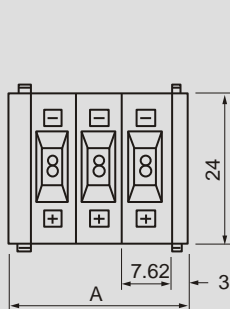
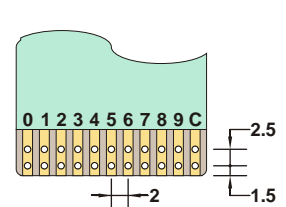

$$A = (7.62 \times N) + 6$$

$$B = (7.62 \times N) + 3$$

$$C = (7.62 \times N) + 3.3$$

N = Número de módulos

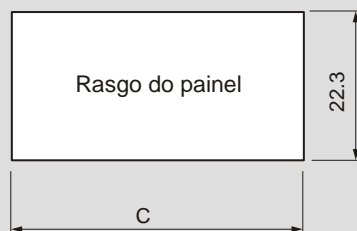
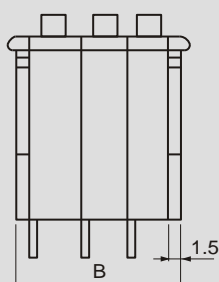

Podem ser utilizados pinos de parada para limitar a rotação.

D Comércio e Assessoria

Pushwheel Switch: GPF31



BCD (GPF3112XX)

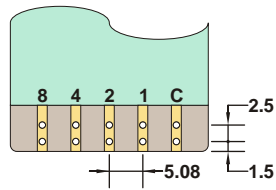

DECIMAL (GPF3122XX)

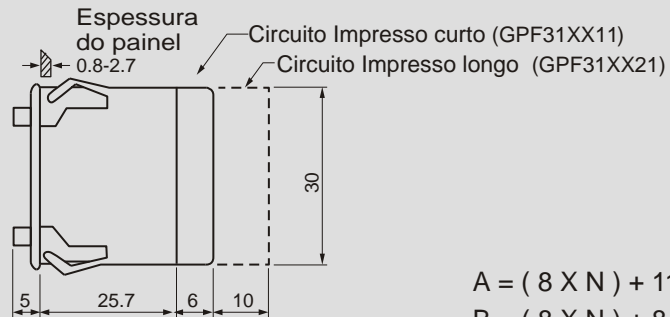
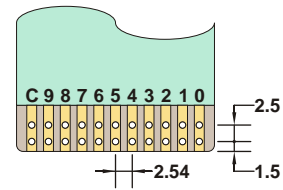

$$A = (8 \times N) + 11$$

$$B = (8 \times N) + 8$$

$$C = (8 \times N) + 8.3$$

N = Número de módulos

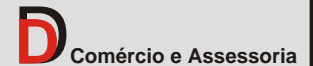
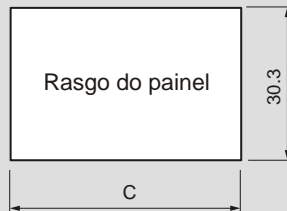

Thumbwheel Switch: GTF31



BCD (GTF3112XX)

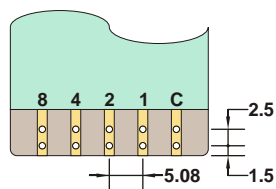

DECIMAL (GTF3122XX)

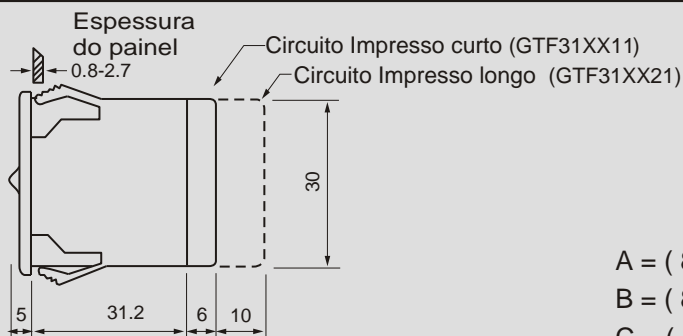
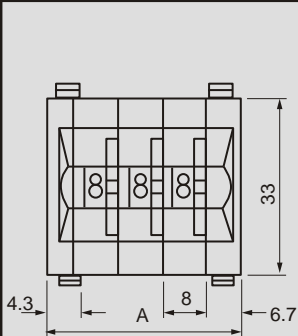
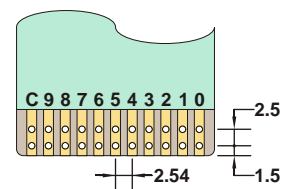

$$A = (8 \times N) + 11$$

$$B = (8 \times N) + 8$$

$$C = (8 \times N) + 8.3$$

N = Número de módulos

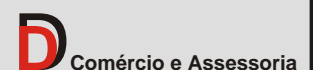
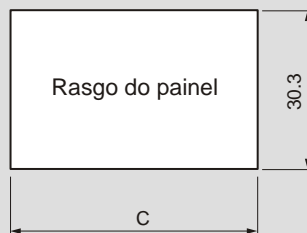
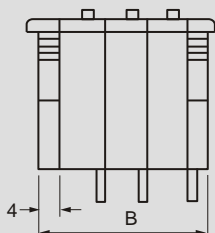

RS300
RS30012 BCD 10 posições
RS30014 HEX 16 posições

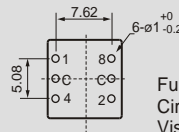
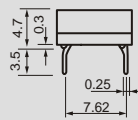
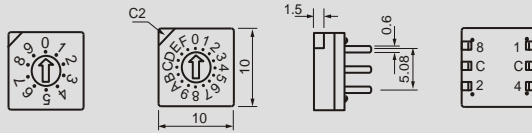
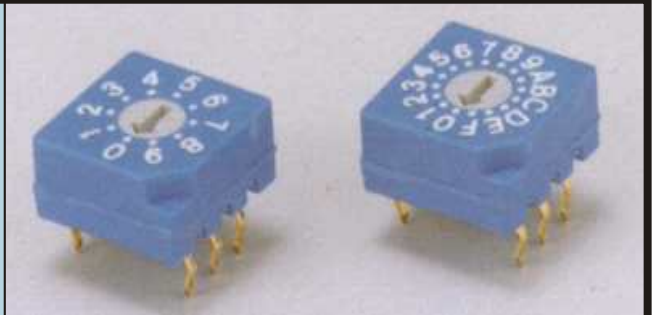

Furação do Circuito Impresso
 Vista por cima

RM300
RM30012 BCD 10 posições
RM30014 HEX 16 posições

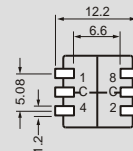
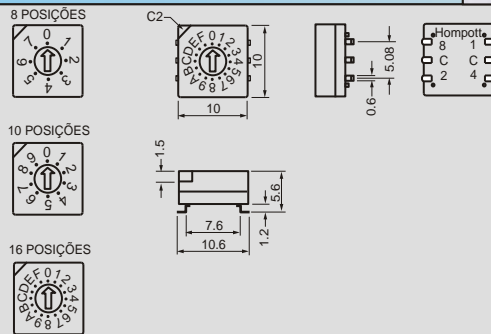
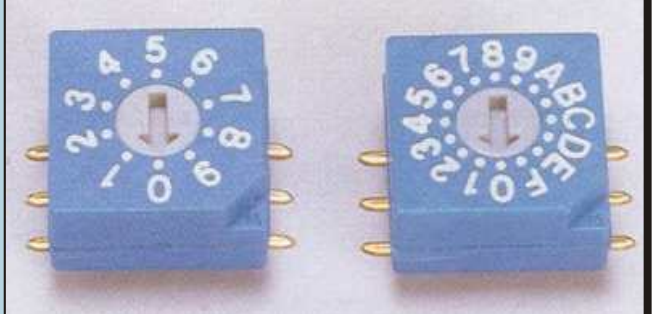

Padrão SMT
 Vista por cima

RR300
RR30012 BCD 10 posições
RR30014 HEX 16 posições

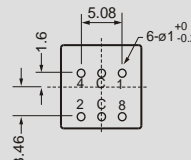
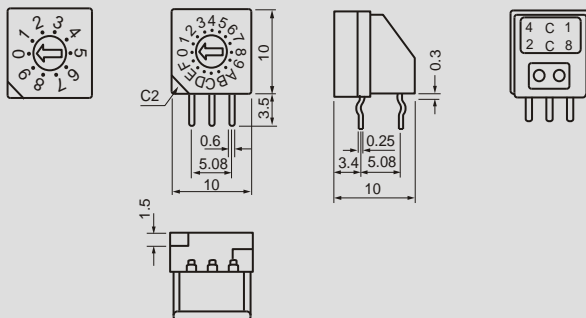
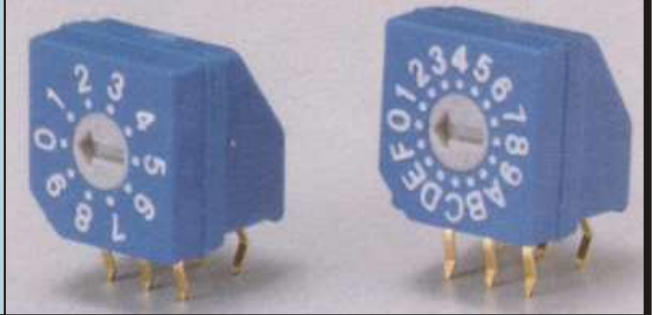

Furação do Circuito Impresso
 Vista por cima

RR307
RR30712 BCD 10 posições
RR30714 HEX 16 posições

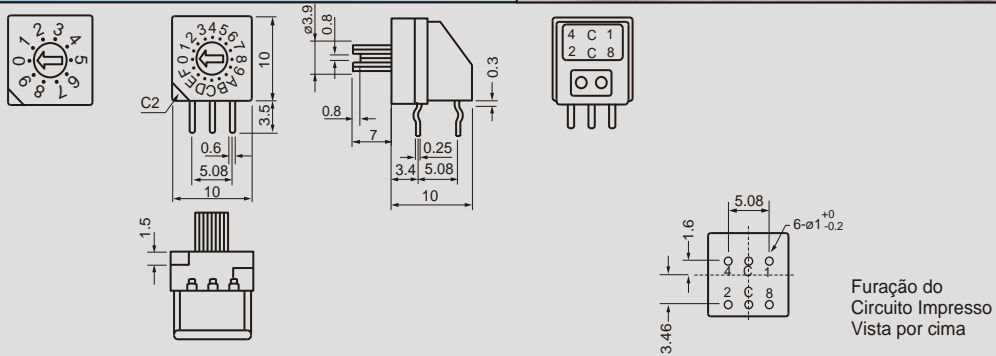
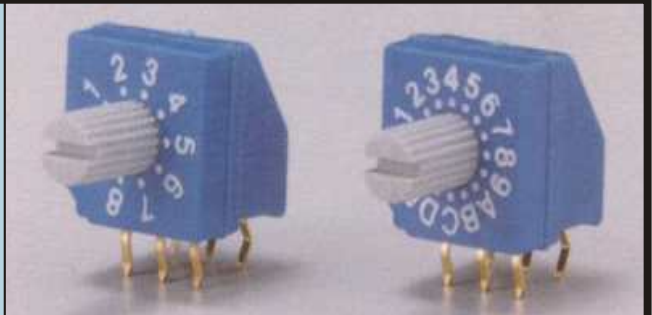

RS403
RS40312 BCD 10 posições
RS40314 HEX 16 posições

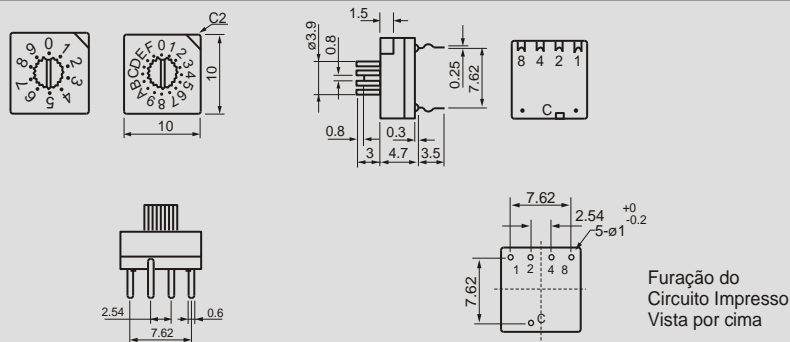
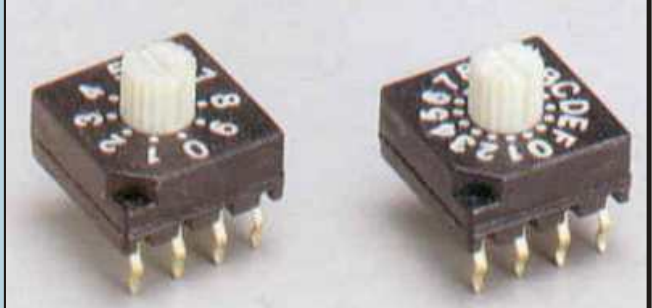

Especificações:

Thumbwheel & Pushwheel Switches

- Tensão de operação: 50V AC / 28V DC
- Corrente de comutação: 100mA
- Corrente de carga: 1A (500mA para série GPF52)
- Resistência do contato: 200mohm
- Resistência de isolamento entre o comum e qualquer saída: 10Mohm mínima. Entre cada saída e parte não condutora: 1000Mohm .
- Rigidez dielétrica entre comum e qualquer saída: 800VAC 1 minuto. Entre cada saída e parte não condutora: 1000VAC 1 minuto.
- Temperatura de operação: -20°C a 65°C.
- Vida Útil Mecânica: 200000 operações.
- Vida Elétrica: 100000 operações.

Rotary Switches

- Tensão de operação: 24V DC
- Corrente de comutação: 100mA
- Corrente de carga: 500mA
- Resistência do contato: 100mohm
- Resistência de isolamento 1000Mohm
- Rigidez dielétrica 300VAC 1 minuto
- Temperatura de operação: -10°C a 70°C.
- Temperatura de solda 250 ° ± 5 durante 5 seg.
- Vida Útil 10000 operações.